

TEAC

T-H300DABmkIII

DAB
Digital Audio Broadcasting

DAB/AM/FM Stereo Tuner OWNER'S MANUAL

Important Safety Instructions	2
Before Use	2
Connection	3
Connecting Antennas (AM/FM)	4
Connecting Antennas (DAB)	5
Names of Each Control	6
Setting up your DAB Tuner	7
Auto Tuning	7
Using the Channel List	8
Using Function Control	9
Changing Display Settings	12
Listening to FM/AM	13
Preset Tuning	14
RDS	16
PTY Search	17
Sleep Timer	18
Dimmer	18
Setting the Clock	19
Setting the Daily Timer	20
How to Reset the Settings to the Factory Defaults	21
Troubleshooting	22
About DAB	23
Specifications	23

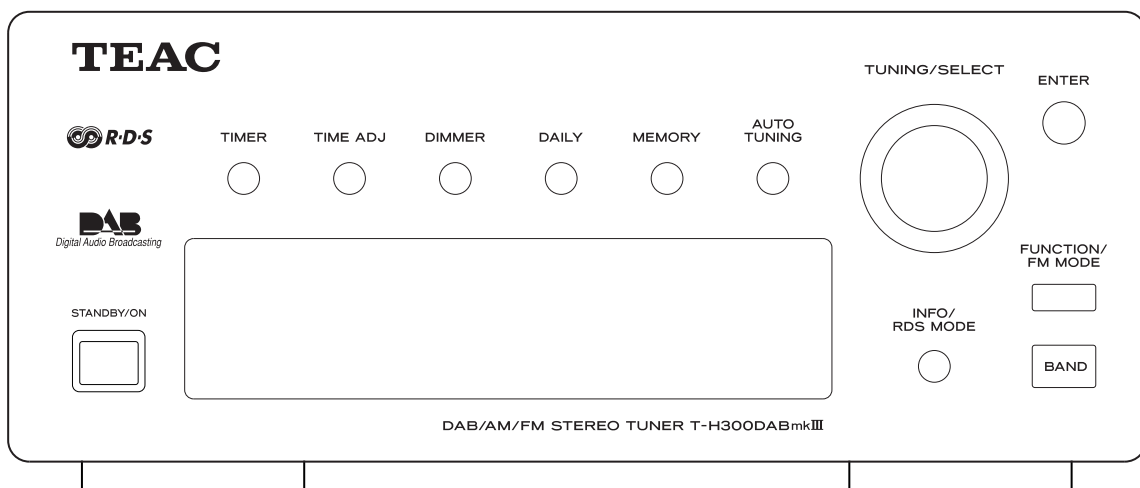

Thank you for choosing TEAC. Read this manual carefully to get the best performance from this unit.



CAUTION
RISK OF ELECTRIC SHOCK
DO NOT OPEN



CAUTION: TO REDUCE THE RISK OF ELECTRIC SHOCK, DO NOT REMOVE COVER (OR BACK). NO USER-SERVICEABLE PARTS INSIDE. REFER SERVICING TO QUALIFIED SERVICE PERSONNEL.



The lightning flash with arrowhead symbol, within an equilateral triangle, is intended to alert the user to the presence of uninsulated "dangerous voltage" within the product's enclosure that may be of sufficient magnitude to constitute a risk of electric shock to persons.



The exclamation point within an equilateral triangle is intended to alert the user to the presence of important operating and maintenance (servicing) instructions in the literature accompanying the appliance.

IMPORTANT SAFETY INSTRUCTIONS

- 1) Read these instructions.
- 2) Keep these instructions.
- 3) Heed all warnings.
- 4) Follow all instructions.
- 5) Do not use this apparatus near water.
- 6) Clean only with dry cloth.
- 7) Do not block any ventilation openings. Install in accordance with the manufacturer's instructions.
- 8) Do not install near any heat sources such as radiators, heat registers, stoves, or other apparatus (including amplifiers) that produce heat.
- 9) Do not defeat the safety purpose of the polarized or grounding-type plug. A polarized plug has two blades with one wider than the other. A grounding type plug has two blades and a third grounding prong. The wide blade or the third prong are provided for your safety. If the provided plug does not fit into your outlet, consult an electrician for replacement of the obsolete outlet.
- 10) Protect the power cord from being walked on or pinched particularly at plugs, convenience receptacles, and the point where they exit from the apparatus.
- 11) Only use attachments/accessories specified by the manufacturer.
- 12) Use only with the cart, stand, tripod, bracket, or table specified by the manufacturer, or sold with the apparatus. When a cart is used, use caution when moving the cart/apparatus combination to avoid injury from tip-over. 
- 13) Unplug this apparatus during lightning storms or when unused for long periods of time.
- 14) Refer all servicing to qualified service personnel. Servicing is required when the apparatus has been damaged in any way, such as power-supply cord or plug is damaged, liquid has been spilled or objects have fallen into the apparatus, the apparatus has been exposed to rain or moisture, does not operate normally, or has been dropped.

- Do not expose this apparatus to drips or splashes.
- Do not place any objects filled with liquids, such as vases, on the apparatus.
- Do not install this apparatus in a confined space such as a book case or similar unit.
- The apparatus draws nominal non-operating power from the AC outlet with its STANDBY/ON switch in the standby position.
- The apparatus should be located close enough to the AC outlet so that you can easily grasp the power cord plug at any time.
- An apparatus with Class I construction shall be connected to an AC outlet with a protective grounding connection.

WARNING: TO PREVENT FIRE OR SHOCK HAZARD, DO NOT EXPOSE THIS APPLIANCE TO RAIN OR MOISTURE.

CAUTION

- DO NOT REMOVE THE EXTERNAL CASES OR CABINETS TO EXPOSE THE ELECTRONICS. NO USER SERVICEABLE PARTS ARE WITHIN!
- IF YOU ARE EXPERIENCING PROBLEMS WITH THIS PRODUCT, CONTACT TEAC FOR A SERVICE REFERRAL. DO NOT USE THE PRODUCT UNTIL IT HAS BEEN REPAIRED.

Before Use

Read this before operation

- As the unit may become warm during operation, always leave sufficient space around the unit for ventilation.
- The voltage supplied to the unit should match the voltage as printed on the rear panel. If you are in any doubt regarding this matter, consult an electrician.
- Choose the installation location of your unit carefully. Avoid placing it in direct sunlight or close to a source of heat. Also avoid locations subject to vibrations and excessive dust, heat, cold or moisture.
- Do not place the unit on the amplifier/receiver.
- Do not open the cabinet as this might result in damage to the circuitry or electrical shock. If a foreign object should get into the unit, contact your dealer or service company.
- When removing the power plug from the wall outlet, always pull directly on the plug, never yank the cord.
- Do not attempt to clean the unit with chemical solvents as this might damage the finish. Use a clean, dry cloth.
- Keep this manual in a safe place for future reference.

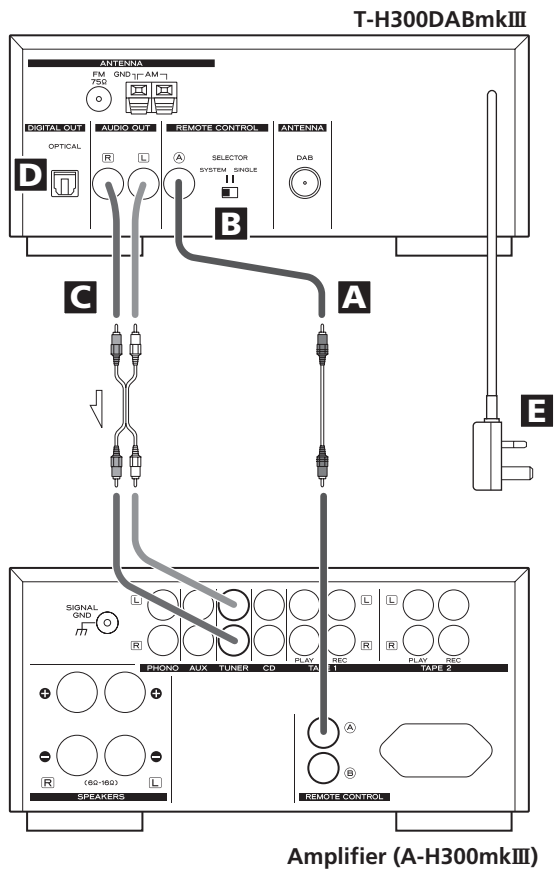

B REMOTE CONTROL SELECTOR

If the REMOTE CONTROL jack is connected to the A-H300mkIII, select 'SYSTEM'. When operating the remote control unit provided with the A-H300mkIII, point it towards the remote sensor of A-H300mkIII.

If the REMOTE CONTROL jack is NOT connected to the A-H300mkIII, select 'SINGLE'.

C LINE OUT jack

Analog 2-channel audio signal is output from this jack. Connect this jack to the TUNER jack of the amplifier (A-H300mkIII) with an RCA cable.

Make sure to connect:

- white plug → white jack (L: left channel)
- red plug → red jack (R: right channel)

D DIGITAL OUT terminal

DAB's digital audio signal is output from this terminal. If you want to record digitally, or decode the signal using an external digital decoder, connect to the digital input terminal of a digital recording device or a decoder using a commercially-available optical digital cable.

- When inserting the plug of the optical cable, the protective shutter of the terminal will open and you should hear it click into position when fully inserted. Be careful that you do not force the plug, because this could result in damage to the protective shutter, the cable, or the unit itself.

E AC Power Cord

After all other connections are complete, connect the plug to the AC wall socket.

Be sure to connect the power cord to an AC outlet which supplies the correct voltage.

Hold the power plug when plugging or unplugging the power cord.

CAUTION:

- Switch off the power to all equipment before making connections.
- Read the instructions of each component you intend to use with this unit.
- Be sure to insert each plug securely. To prevent hum and noise, avoid bundling the signal interconnection cables together with the AC power cord or speaker cables.

A REMOTE CONTROL jack

If you have TEAC A-H300mkIII, convenient system control operations are available:

- When you tune in a station, the input selector of the A-H300mkIII is set to 'TUNER' automatically.
- You can use the system remote control unit RC-957 or RC-1091 (provided with A-H300mkIII) to operate this unit.

Connect the REMOTE CONTROL jack to the REMOTE CONTROL jack (A or B) of A-H300mkIII or PD-H300mkIII with the provided remote control connection cord. Read the owner's manual of A-H300mkIII for details.

Note:

The remote control unit is not provided with this unit.

Connecting Antennas (AM/FM)

AM Indoor Loop Antenna

The high-performance AM loop antenna provided with this unit is sufficient for good reception in most areas. To stand the loop antenna on a surface, fix the claw to the slot in the antenna base.

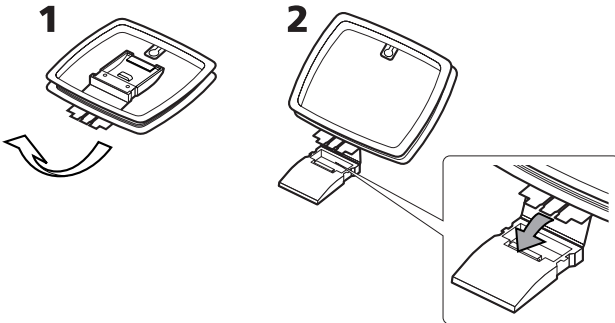

Connect the loop antenna's wires to the AM antenna terminals.

Place the antenna on a shelf or hang it on a window frame, etc., in the direction which gives the best reception. Keep all other wires such as power cords, speaker wires or interconnect wires as far away as possible from the antenna.

AM Loop Antenna

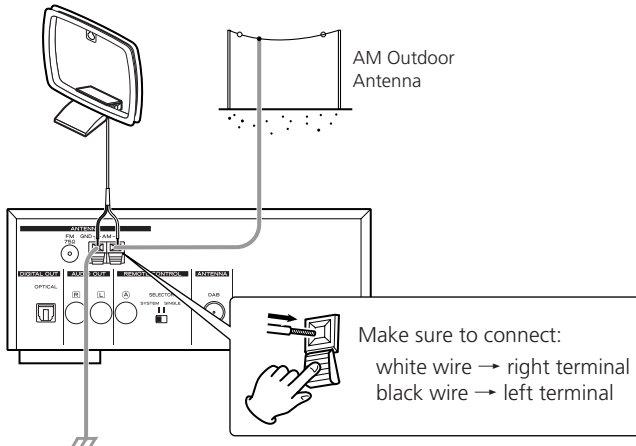

- If the AM loop antenna provided does not deliver sufficient reception (often due to being too far from the transmitter or in a concrete building, etc.), it may be necessary to use an outdoor AM antenna.

Use either a high quality commercial AM antenna or, if not available, an insulated wire more than 5 m long, strip one end, and connect this to the terminal as shown.

The antenna wire should be strung outdoors or indoors near a window. For better reception, connect the GND terminal to a reliable ground.

Note:

Even when using an outdoor AM antenna, do not disconnect the AM loop antenna.

FM Indoor Antenna

Connect the lead-type FM antenna to the FM 75Ω socket, extend the lead and tune the tuner to your favorite station (see page 13). Adjust the antenna in a suitable location like a window frame or wall until the reception is best and then affix the antenna in that position using thumb tacks, push pins or any other suitable means.

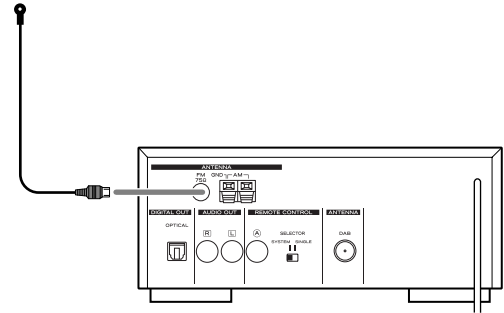

FM Outdoor Antenna

In an area where FM signals are weak, it will be necessary to use an outdoor FM antenna. Generally, a 3-element antenna will be sufficient; if you live in an area where the FM signals are particularly weak, it may be necessary to use one with 5 or more elements.

- Disconnect the FM indoor antenna when using an outdoor antenna.

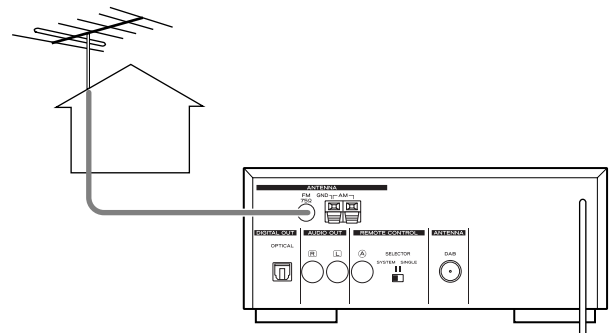

Connecting Antennas (DAB)

DAB Indoor Antenna

Connect the T-type DAB antenna to the DAB socket, extend the lead vertically and attach it to a window frame or wall with thumbtacks, or the like, where reception is best.

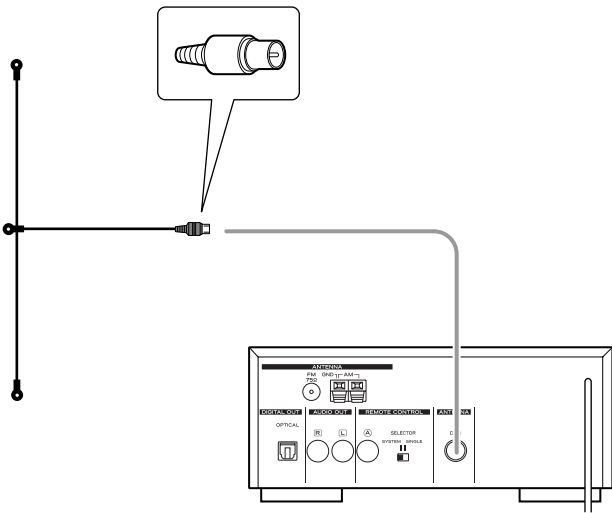

- You can check the antenna adjustment or positioning for the best reception by viewing the signal strength on the display.

The signal strength is displayed as a bar graph by pressing the ENTER button once.

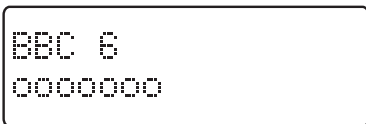

DAB Outdoor Antenna

In an area where DAB signals are weak, it will be necessary to use an outdoor DAB antenna. There are two main types available.

Dipole:

For use in marginal signal areas. This type of antenna is omnidirectional and should increase the strength of all DAB stations being received.

Multi-element antenna:

Also for use in marginal or poor signal areas. This type of antenna is directional and has high gain. This antenna needs to be pointed at the transmitter you want to listen to.

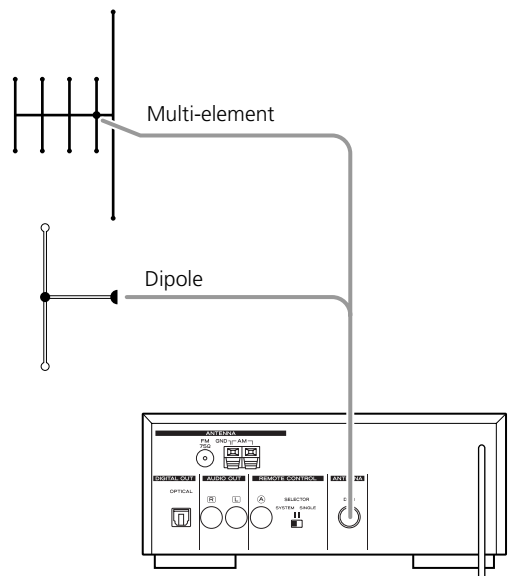

- It is possible to use a TV or FM antenna with your DAB tuner as this is normally mounted externally. This may give a stronger signal than a simple internal antenna, however it would not be tuned specifically for DAB reception.

You would need to change the plug on your TV/FM antenna to an F type, and it may also be necessary to use a signal booster to enhance the signal.

Names of Each Control

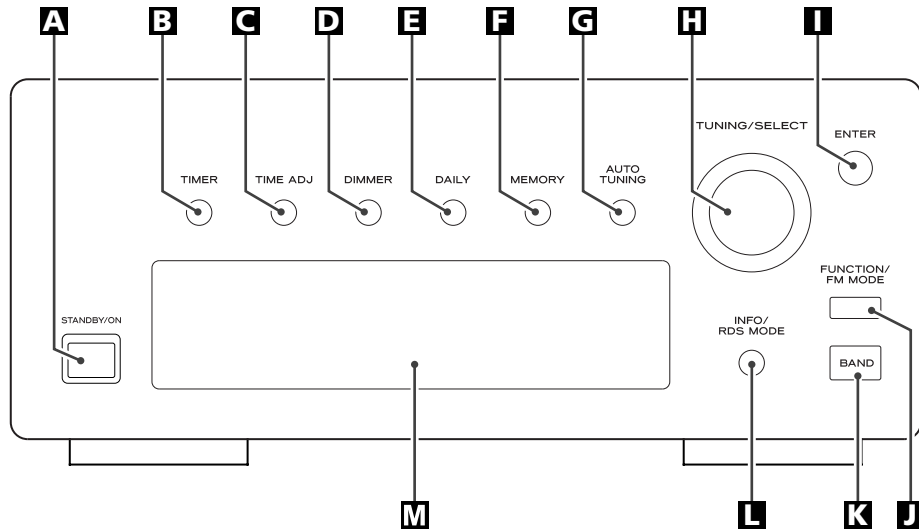

A STANDBY/ON

Press this button to turn the unit on or standby. The standby indicator lights when the unit is in the standby mode. When the unit is turned on, it goes off.

- If the T-H300DABmkIII is connected to the A-H300mkIII with a remote control cord, you can switch ON/standby both the A-H300mkIII and the T-H300DABmkIII by pressing the STANDBY/ON button of the A-H300mkIII.

The equipment draws nominal non-operating power from the AC outlet with its STANDBY/ON switch in the STANDBY position.

B TIMER

Use this button to turn on or off the timer function.

C TIME ADJ

Use this button to adjust clock.

D DIMMER

Use this button to dim the display.

E DAILY

Use this button to set timer.

F MEMORY

Use this button to store preset channels into memory.

G AUTO TUNING

Press this button to activate auto location of all available DAB services.

Press once for UK services or, hold for longer than 2 seconds to activate international search.

H TUNING/SELECT

Turn this knob to tune in FM/AM stations or select parameters in the function menus.

I ENTER

Use this button to enter your selection.

J FUNCTION/FM MODE

In DAB mode, activates features such as station order, manual tune, DRC value, SW version indication, signal error rate. It is also possible to 'tidy' the station list to remove stations which are in the memory but have no service provided.

In FM tuner mode, use this button to select stereo or monaural.

K BAND

Use this button to select FM, AM or DAB.

L INFO/RDS MODE

In DAB mode, this button is used to change the text content on the second line of the display, to show DLS (Dynamic Label Segment, info text supplied by each radio station), Programme type (classification given by the radio station ie: Pop music or Rock), Multiplex name (name of multiplex broadcaster), Time & date, Bitrate, or Channel and frequency. In FM mode, this button is used to select the RDS mode.

M Display

Setting up your DAB Tuner

The first time you turn on the unit, it will scan for DAB channels and build a channel list.

Press the **STANDBY/ON** switch to turn the unit on.

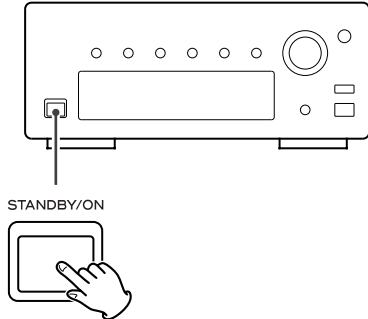

The following screen will display for 2 seconds.

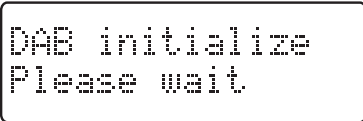

The unit will scan for broadcast services in the local area and add them to the channel list as they are found. The scan should take about 10 seconds.



As channels are added to the channel list the number of channels found is displayed.

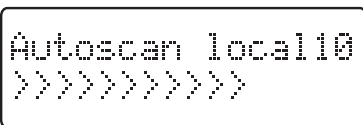

After broadcast services have been found the channels are listed in alphanumeric order.

- If no broadcast services are found, please check that the antenna is correctly connected to the unit.

Auto Tuning

If you move the unit to a new area or you want to check to see if there are new channels available in your area, you can scan to find new channels automatically.

Press the **AUTO TUNING** button.

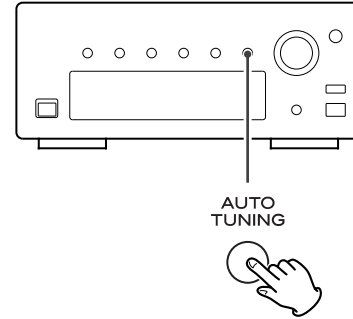

The unit will scan for any new channels and add the channels found to the channel list.

- Press and hold the AUTO TUNING button for longer than 2 seconds to activate international search.

Using the Channel List

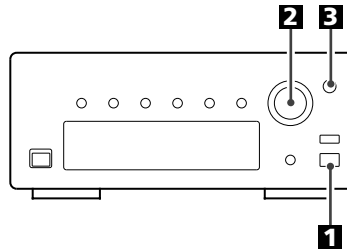

Follow the steps below to tune in and listen to the channels found by the unit.

1 Select DAB by pressing the BAND button.

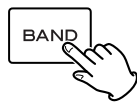

2 Turn the TUNING/SELECT knob to the left or right to scroll through the channels in the channel list.

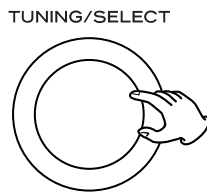

The present channel is displayed on the first line and the changing list is displayed on the second line.

3 When you have found a channel that you want to listen to, press the ENTER button once.



The channel is tuned in and channel information is displayed.

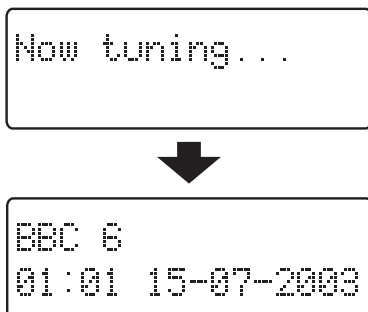

- To display the signal strength of a channel, press the ENTER button again. The signal strength is display. Press the ENTER button once again to cancel the signal strength display.
- Channels are displayed in alphanumeric order in the channel list, with numbers coming first. So, stations such as 6 Music from the BBC will be listed early in the list.
- If a channel is no longer broadcasting or the unit is moved out of the area of a broadcast channel, the unit will no longer be able to tune in the channel. If the channel cannot be tuned in a question mark (?) is displayed in front of the channel name. If you select this channel to tune in by pressing the ENTER button, 'No stations Available' is displayed.
- You can remove a channel that is no longer available from the channel list. See Tidy station, page 9.

Using Function Control 1

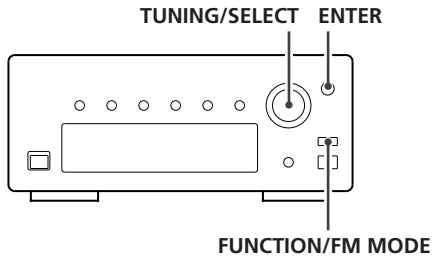

In DAB mode, use function control to set system options. There are 6 options in the function control.

- Station order
- Signal error rate
- Preset tune
- Software version
- DRC value
- Manual tune

Station order

Use station order to set the order in which stations are listed. There are four orders: Favourite, Alphanumeric, Active and Tidy.

1 While listening to a DAB broadcast press the **FUNCTION/FM MODE** button.



2 Turn the **TUNING/SELECT** knob until 'Station order' is displayed in the second line of the display.

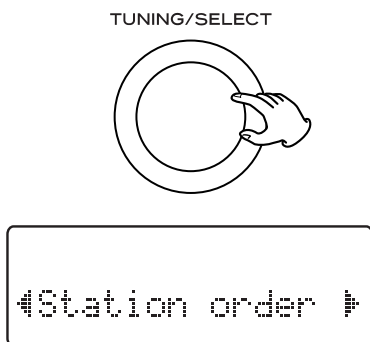

3 Press the **ENTER** button.

The current option is displayed in the first line of the display.



4 Turn the **TUNING/SELECT** knob until the desired option is displayed in the second line of the display.

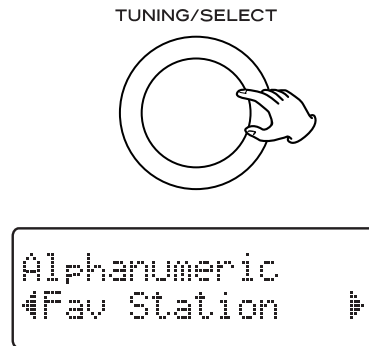

Fav Station (Favourite station)

As you tune in stations and listen to them the unit will memorize the top ten stations you listen to and list them at the top of the channel list. A Favourite station in the channel list has '♥' displayed after the station name on the first line of the display.

Alphanumeric

This is the default order. Channels are listed by name with numbers first and then alphabetically by letters in the channel name.

Active station

This option will list active stations at the top of the channel list and channels that are in the list but have no service in your area to be listed last in the channel list.

Tidy station

This option will list active stations and remove any channels that are in the list but have no service in your area from the channel list.

♥ → preset

This option takes your top ten Favourite channels and assigns them to preset numbers 1 - 10.

This option is only available after 'Fav Station' option has been turned on. See above.

5 Press the **ENTER** button.



Sig error rate (Signal error rate)

This option shows the digital bit error rate (0-99) of the currently tuned channel. This is for information only and no adjustment is available. The lower the figure the better the quality of the received broadcast.

- 1 While listening to a DAB broadcast press the **FUNCTION/FM MODE** button.

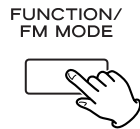

- 2 Turn the **TUNING/SELECT** knob until 'Sig error rate' is displayed in the second line of the display.

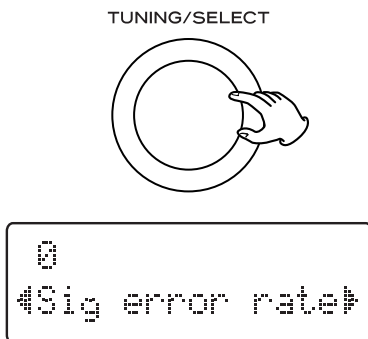

The digital bit error rate of the current tuned channel is displayed.

Sw version (Software version)

This option shows the version number of the installed software. This is for information only and no adjustment is available.

- 1 While listening to a DAB broadcast press the **FUNCTION/FM MODE** button.



- 2 Turn the **TUNING/SELECT** knob until 'Sw version' is displayed in the second line of the display.

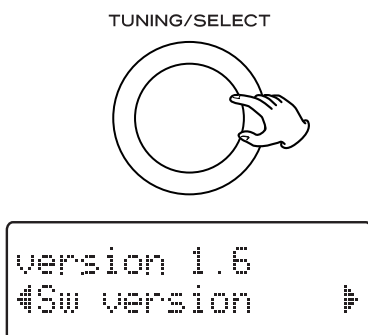

Preset tune

Use this option to select the DAB preset station.

- 1 While listening to a DAB broadcast press the **FUNCTION/FM MODE** button.

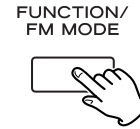

- 2 Turn the **TUNING/SELECT** knob until 'Preset tune' is displayed in the second line of the display.

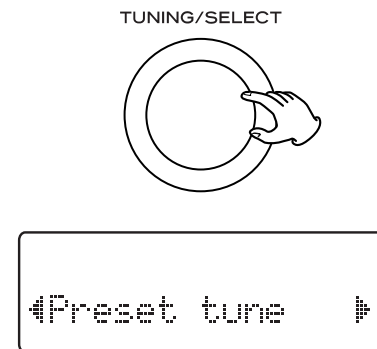

- 3 Press the **ENTER** button.



The currently tuned station is displayed.

- 4 Turn the **TUNING/SELECT** knob until the desired preset station is displayed.

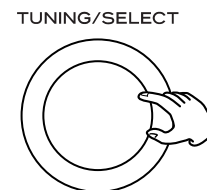

- 5 Press the **ENTER** button to select the preset station.

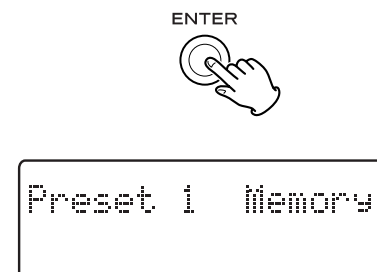

- If the station is not broadcasting, 'Empty' is displayed.
- If the station is available, 'Memory' is displayed.

DRC value

This option sets the Dynamic Range Control (DRC) value to be applied to received broadcasts. DRC is used to reduce the range between high and low volumes of audio and is sometimes applied at the broadcast source. Pop music may have a high value of DRC applied, appropriate for constantly high listening levels, while classical music broadcasts may have no DRC applied to allow the listener to hear the full dynamic range of the source volume.

There are three values of DRC you can apply.

- 0 : None
- 1/2 : Medium
- 1 : Maximum

- 1** While listening to a DAB broadcast press the **FUNCTION/FM MODE** button.



- 2** Turn the **TUNING/SELECT** knob until 'DRC value' is displayed in the second line of the display.

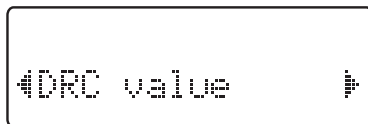

- 3** Press the **ENTER** button.



- 4** Turn the **TUNING/SELECT** knob until the desired level of DRC is displayed in the second line of the display.

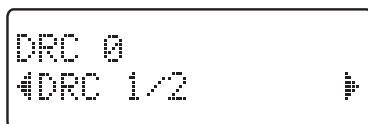

- 5** Press the **ENTER** button.



Manual tune

This option allows you to manually tune in a channel and view a continuously updated display of the strength of the signal. This may be useful when adjusting or positioning an antenna for better reception.

- 1** While listening to a DAB broadcast press the **FUNCTION/FM MODE** button.

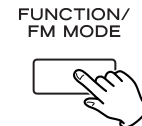

- 2** Turn the **TUNING/SELECT** knob until 'Manual tune' is displayed in the second line of the display.

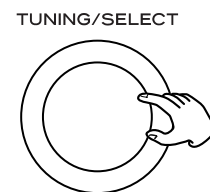

- 3** Press the **ENTER** button.



'Manual tune' is displayed on the first line of the display.

- 4** Turn the **TUNING/SELECT** knob to scroll through the channel list.

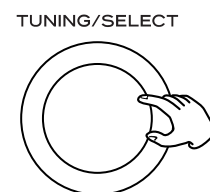

- 5** Press the **ENTER** button when the channel you wish to tune in is displayed in the second line of the display.



The signal strength indicator is displayed.

- 6** While viewing the indicator, adjust or reposition the antenna until the best reception is indicated.

- 7** Press the **ENTER** button to cancel Manual tune and resume normal reception.



Changing Display Settings

You can choose the type of information displayed in the second line of the display while listening to a DAB channel.

Each time the **INFO/RDS MODE** button is pressed, the information is displayed as follows.

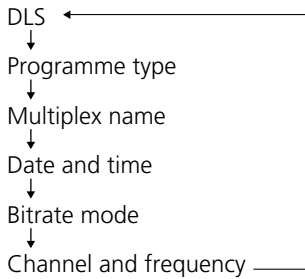
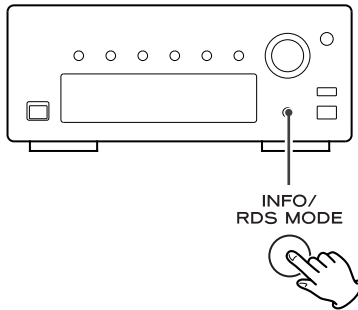

DLS

The Dynamic Label Segment (DLS) is the scrolling text label supplied by the radio station. It may be information on music titles or details regarding the programme or station.



Programme type

This is a description of the type of broadcast supplied by the radio station such as Pop, Rock or Classical music.

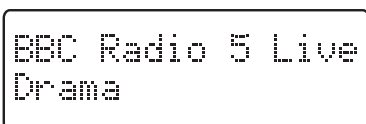

Multiplex name

This displays the name of the Multiplex that is broadcasting the programme.



Date and time

This displays the current date and time, which is supplied by the radio station and should always be accurate.

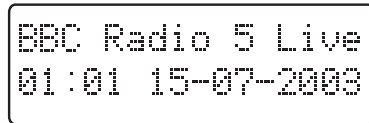

- The clock setting will be automatically adjusted according to the clock time data. If you tune in a DAB station broadcasting incorrect clock time data, the clock might be wrongly adjusted, and that may eventually affect the timer operation.

No matter which DAB mode is selected, the unit receives clock time data and adjusts the clock.

Bitrate mode

This displays the bitrate of the current playing broadcast.

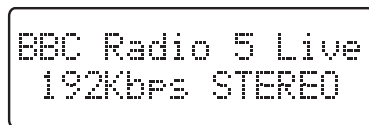

Channel and frequency

This displays the channel and frequency of the current playing broadcast.

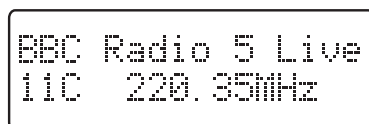

Listening to FM/AM

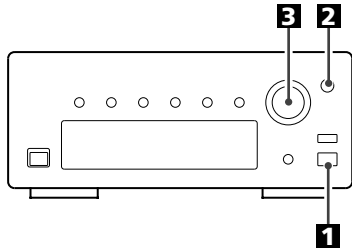

1 Select AM or FM by pressing the BAND button.

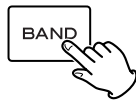

2 Select the desired tuning mode by pressing the ENTER button.

Each time the ENTER button is pressed, the tuning mode changes as follows:

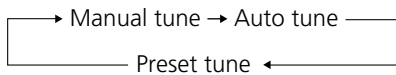

3 Select the station you want to listen to.

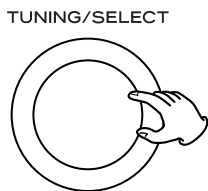

Manual tuning mode

Turn the TUNING/SELECT knob until the station you want to listen to is found.

The frequency changes by a fixed step (FM: 50 kHz steps, AM: 9 kHz steps).

Auto tuning mode

Turn the TUNING/SELECT knob slightly to begin auto tuning. When a station is found, the tuning process stops automatically.

- Press the ENTER button to stop the auto tuning.

FUNCTION/FM MODE Button

Pressing this button alternates between Stereo mode and Mono mode.

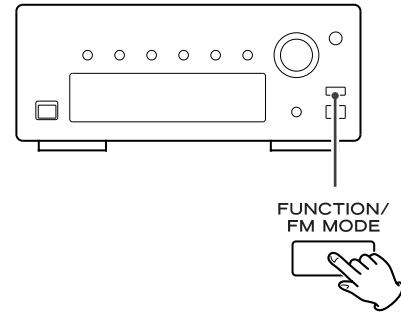

Stereo:

FM stereo broadcasts are received in stereo and the 'STEREO' is displayed.

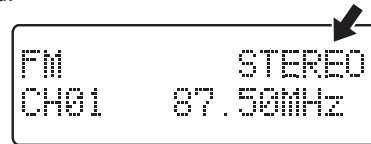

Mono:

To compensate for weak FM stereo reception, select this mode. Reception will now be forced monaural, reducing unwanted noise.

Preset Tuning

Preset Manually (FM/AM/DAB)

You can store up to 30 FM, 30 AM and 10 DAB stations.

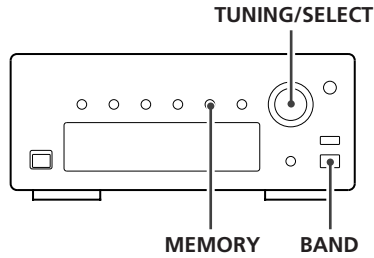

1 Select DAB, AM or FM by pressing the **BAND** button.



2 Tune the station you would like to store.

3 Press the **MEMORY** button briefly.

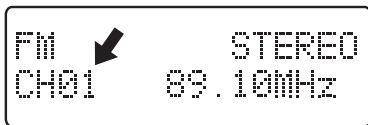

'CH01' blinks on the display.

4 Within 4 seconds, select the preset you would like to use for this station using the **TUNING/SELECT** knob.

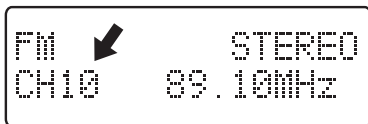
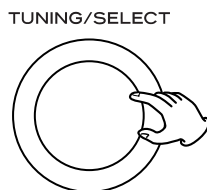

You can also use the numeric buttons of the remote control unit provided with the A-H300mkIII.

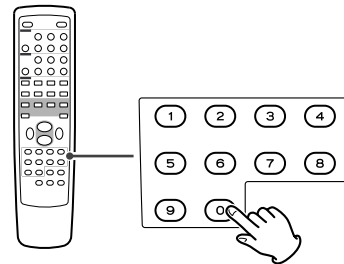

For instance, to select preset number 25, first press the TUNER button, and then press '2' and '5'.

To select numbers less than 10, press '0' and then the number. As an example, to select number 5, press '0' and '5'. (Optionally, you may press just the number '5' and then wait a few seconds.)

5 Within 4 seconds, press the **MEMORY** button.



• If you don't press the memory button within 4 seconds after selecting the channel:

- With DAB: the station will be automatically stored.
- With FM/AM: the selection will be canceled.

To store more stations, repeat steps **1** to **5**.

Preset Automatically (FM/AM only)

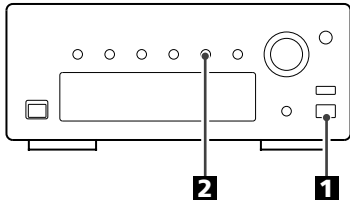

1 Select AM or FM by pressing the BAND button.

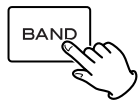

2 Press the MEMORY button for more than 3 seconds.



Up to 30 of the best received stations in your area will be stored automatically.

How to select FM/AM preset stations

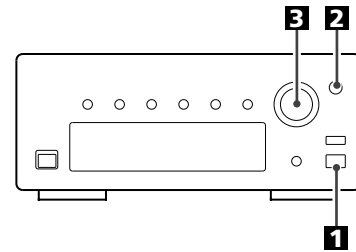

1 Select AM or FM by pressing the BAND button.

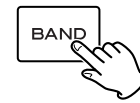

2 Select 'Preset tune' by pressing the ENTER button.



3 Select a preset channel.

Turn the TUNING/SELECT knob until the desired preset station is found.

TUNING/SELECT

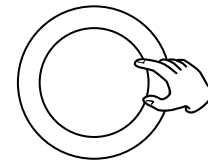

- Preset channels can also be selected by the numeric buttons of the remote control unit provided with A-H300mkIII.
- When using the remote control unit, you can skip step **2**.

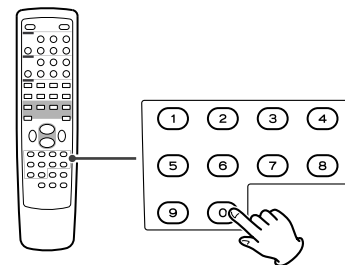

How to select DAB preset stations

See 'Preset tune' of page 10.

The Radio Data System(RDS) is a broadcasting service which allows stations to send additional information along with the regular radio programme signal.

RDS works on the FM waveband in Europe only.

1 Tune in an FM station (see steps 1 to 3 of page 13).

2 Press the RDS MODE button.

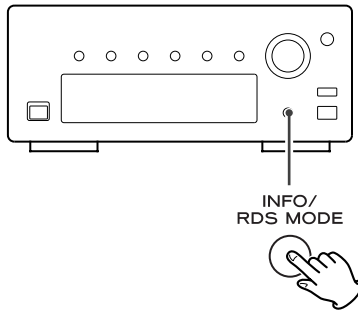

Each time the RDS MODE button is pressed briefly, the RDS mode is changed as follows:

PROGRAM SERVICE

When you select PROGRAM SERVICE, 'PROGRAM SERVICE' will blink for about 3 seconds and then the programme service name or a station's name will be displayed. If there is no programme service data, the frequency will be displayed.

RDS CLOCK TIME

displays the information about times provided from the station.

When you select RDS CLOCK TIME, 'RDS CLOCK TIME' will blink for about 3 seconds and then the clock time will be displayed.

If there is no time data, 'NO CT' will be displayed.

RDS PROGRAM TYPE

When you select RDS PROGRAM TYPE, 'RDS PROGRAM TYPE' will blink for about 3 seconds and then the programme type will be displayed.

RDS RADIO TEXT

When you select RDS RADIO TEXT, 'RDS RADIO TEXT' will blink for about 3 seconds and then the news of stations composed of up to 64 symbols will be displayed.

If there is no radio text data, RDS mode will be automatically switched to PROGRAM SERVICE mode.

TRAFFIC ANNOUNCE

When you select TRAFFIC ANNOUNCE, 'TRAFFIC ANNOUNCE' will blink for 3 seconds and then the unit searches for a traffic announcement.

- When a traffic programme is found, the TRAFFIC ANNOUNCE mode is switched to PROGRAM SERVICE mode. If the station currently selected is transmitting a traffic program signal, the RDS mode will be switched to PROGRAM SERVICE mode without searching for a traffic program.

When the A-H300mkIII and T-H300DABmkIII is connected by remote control cords

After selecting TRAFFIC ANNOUNCEMENT, you can select any other source by turning the INPUT SELECTOR of the A-H300mkIII.

If a station broadcasting traffic announcement is found, the INPUT SELECTOR of the A-H300mkIII will be automatically switched to 'TUNER'. If the station stops broadcasting traffic announcement, the INPUT SELECTOR will automatically return to the previously selected source.

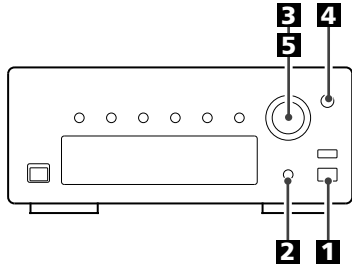

You can search for stations by programme type.

1 Select FM by pressing the BAND button.

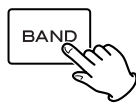

2 Press the INFO/RDS MODE button for more than 3 second.



3 Select the desired programme type (PTY) by turning the TUNING/SELECT knob.

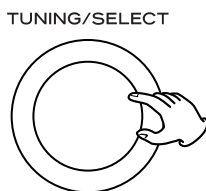

Select your desired one from among 31 kinds of PTY programmes. The programme type will blink.

4 Press the ENTER button.



The programme type stops blinking.

5 Turn the TUNING/SELECT knob.

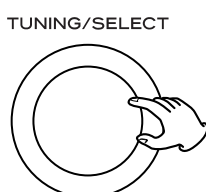

Search starts.

- When the programme that you have selected is found, searching stops and the programme type will be displayed.
- If the same programme type is not found during PTY Search, it will stop at the beginning frequency.
- If you want to stop searching, press the INFO/RDS MODE button.

News	:brief announcements, events, public opinion, reports, actual situations.
Current Affairs	:a kind of suggestion including practical announcements other than news, documents, discussion, analysis and so on.
Information	:daily information or reference such as weather forecast, consumer guide, medical assistance and so on.
Sport	:sports related programs.
Education	:educational and cultural information.
Drama	:all kinds of radio concert and serial drama.
Cultures	:all aspects of national or local culture including religious events, philosophy, social science, language, theatre, and so on.
Science	:programmes on natural science and technology
Varied Speech	:popular programmes such as quiz, entertainment, private interview, comedy, satire and so on.
Pop Music	:programme on commercial, practical and popular songs, and sale volume of discs, etc.
Rock Music	:practical modern music generally composed and played by young musicians.
Easy Listening	:popular music usually lasting for less than 5 minutes.
Light Classics M	:classical music, instrumental music, chorus, and light music favored by non-professionals.
Serious Classical	:orchestra including great operas, symphony, chamber music and so on.
Other Music	:other music styles (Rhythm & Blues, Reggae, etc.)
Weather & Metr	:weather reports, forecast
Finance	:financial reports, commerce, trading
Children's Progs	:children's programmes
Social Affairs	:social affairs
Religion	:religious programmes
Phone In	:programme in which the public expresses its view by phone.
Travel & Touring	:travel reports
Leisure & Hobby	:programmes concerning recreational activities
Jazz Music	:jazz music
Country Music	:country music
National Music	:national music
Oldies Music	:music from the so-called golden of popular music
Folk Music	:folk music
Documentary	:documentaries
Alarm Test	
Alarm-Alarm !	:a programme notifying an emergency or a natural disaster.

Sleep Timer

This function is available only when the T-H300DABmkIII (tuner) is connected to the A-H300mkIII (amplifier) with a remote control cord. Use the remote control unit provided with A-H300mkIII.

The power can be switched off after a specified amount of time. Press the SLEEP button repeatedly until desired time appears on the display.

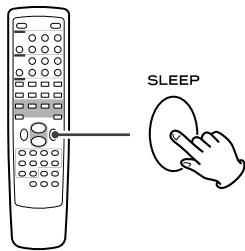

SLEEP 90 (80 ... 10)

The power will be switched off 90 (80 ... 10) minutes later.

(normal display)

The sleep timer is off.

- The display is dimmed when you set the sleep timer.
- If you want to check the remaining time, press the SLEEP button once. The remaining time will be displayed for 2.5 seconds, and return to the normal display.

Dimmer

Press the DIMMER button to dim the display. Press the button again to cancel the dimmer function.

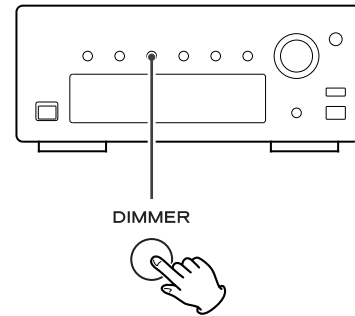

- This function will be cancelled when the unit is turned off.
- If the PD-H300mkIII is connected to the T-H300DABmkIII with a remote control cord, the display of both the PD-H300mkIII and the T-H300DABmkIII will be dimmed.

Setting the Clock

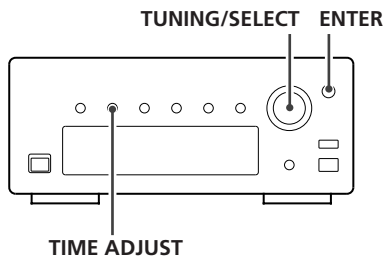

1 Press the TIME ADJ button.



'C-time' (current time) appears on the display, and the 'hour' value blinks.

- You cannot adjust the clock when the unit is in the standby mode.
- When no action is taken for 60 seconds, the time setting mode will be cancelled.
- The unit uses the 24 hour 'military' clock.

2 Turn the TUNING/SELECT knob to set the current hour.

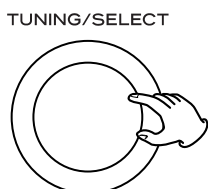

3 Press the ENTER button.



The 'minute' value blinks.

4 Turn the TUNING/SELECT knob to set the current minute.

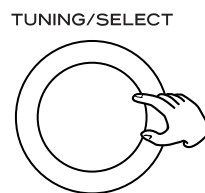

5 Press the ENTER button.



The clock starts from 00 second.

Setting the Daily Timer

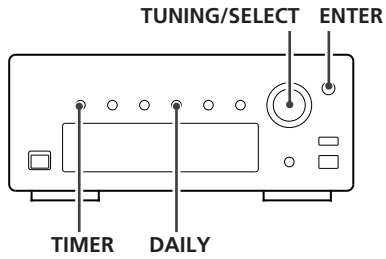

This function is available only when the T-H300DABmkIII (tuner) is connected to the A-H300mkIII (amplifier) with a remote control cord.

- Adjust the clock before setting the timer.
- When no action is taken for 60 seconds, the timer setting mode will be cancelled.

1 Press the **DAILY** button.



'On time' appears on the display, and the 'hour' value blinks.

2 Turn the **TUNING/SELECT** knob to set the start time (hour), and press the **ENTER** button.

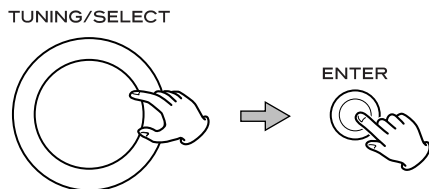

The 'minutes' value blinks.

3 Turn the **TUNING/SELECT** knob to set the start time (minutes), and press the **ENTER** button.

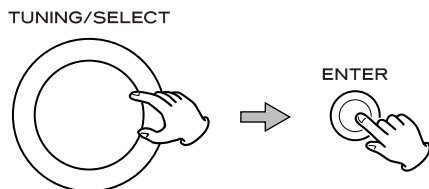

'Off time' appears on the display, and the 'hour' value blinks.

4 Turn the **TUNING/SELECT** knob to set the stop time (hour), and press the **ENTER** button.

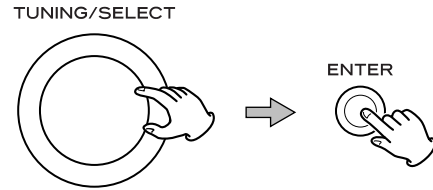

5 Turn the **TUNING/SELECT** knob to set the stop time (minutes), and press the **ENTER** button.

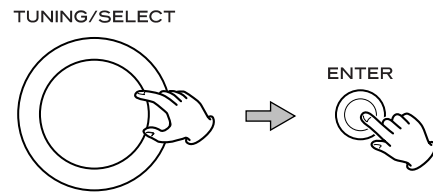

Now the timer setting is stored in memory.

6 Press the **TIMER** button once or twice until 'Timer On' briefly appears on the display.



When the timer is on, the timer indicator '⏰' lights on the display.

7 Prepare for timer operation.

Adjust the volume of the amplifier, tune in a station, etc.

How to Reset the Settings to the Factory Defaults

- 8 Press the STANDBY/ON button of the A-H300mkIII to turn all the units standby.**

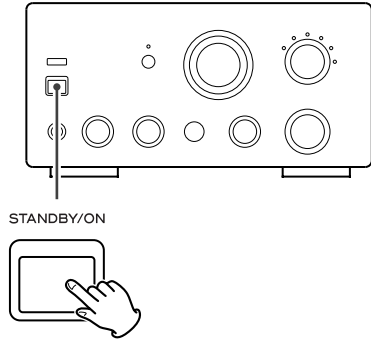

All the units connected by remote control cords will turn on and off at the specified time every day.

- When the timer is on and the power is in the standby mode, the standby indicator blinks once in every 5 seconds.

How to turn on or off the timer function

When you press the TIMER button, the current status ('Timer Off' or 'Timer On') briefly appears on the display. Within 2 seconds press the TIMER button again to turn it On or Off. (When the timer is on, the timer indicator '⏰' lights on the display.)

If the power supply is interrupted for 14 days or longer, all the settings kept in memory (such as preset stations and timer settings) will be erased.

It will take more than 3 days after plugging the power cord into the outlet to charge enough electricity for the memory backup function.

If you want to manually initialize the settings:

1. If the unit is on, press the STANDBY/ON button to turn it standby.
2. Hold down the FUNCTION/FM MODE button for more than 4 seconds.

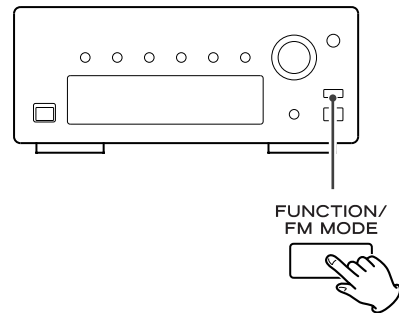

'Factory reset...' appears on the display, and all the settings is reset to the default settings.

If you experience any problems with the unit, please take a moment to look through this chart and see if you can solve the problem yourself before you call your dealer or a TEAC service center.

General

No power

- ➔ Check the connection to the AC power supply. Check and make sure the AC source is not a switched outlet and that, if it is, the switch is turned on. Make sure there is power to the AC outlet by plugging another item such as a lamp or fan.

No sound

- ➔ Check the connection to the amplifier.
- ➔ Check the operation of the amplifier.
- ➔ Ensure that T-H300DABmkIII and connected amplifier are turned on.

Cannot listen to any station, or signal is too weak.

- ➔ Make sure the antenna is properly connected (see page 6).
- ➔ Tune in the station properly (see page 13).
- ➔ Install the antenna again after relocating it to a better reception position.
- ➔ An external antenna may be required.

Sound is noisy.

- ➔ Place the antenna as far away from a TV or a CD player as possible.
- ➔ If a TV or a CD player is near the unit, turn it off.

Though the broadcast is stereo, it sounds monaural.

- ➔ Press the FUNCTION/FM MODE button (see page 13).

DAB tuner

No sound.

- ➔ Ensure that the T-H300DABmkIII has been able to locate DAB stations.

'NO stations Available' appears on the display.

- ➔ Check that antenna is connected (see page 5).
- ➔ Ensure that DAB coverage exists in your area.

Cannot access secondary services.

- ➔ At the time of publishing not many secondary services are available, this will increase as more DAB stations start broadcasting. If a secondary service station is available, the secondary indicator >> will be displayed next to the station name.

Display goes out or displayed 'service off air'.

- ➔ This may occur if a broadcaster changes the label of a service or removes a label whilst you are listening to it. The T-H300DABmkIII will try to retune to this station, or alternatively follow the procedure for auto tune on page 7.

Cannot listen to the selected station.

- ➔ Ensure you have pressed the ENTER button when you want to listen to your selection. The station you are currently listening to will be displayed on the first line of the display, as you scroll through the station order list the second line will show other station options. Press the ENTER button to activate your selection.

A burbling sound is heard on some stations.

- ➔ DAB like other digital media is good at producing quality audio from a low level signal, however if this signal level is too low a 'burbling' sound can sometimes be heard. To reduce this, try repositioning your antenna to gain maximum signal strength.

If normal operation cannot be recovered, unplug the power cord from the outlet and plug it again.

Maintenance

If the surface of the unit gets dirty, wipe with a soft cloth or use diluted neutral cleaning liquid. Be sure to remove any fluid completely. Do not use thinner, benzene or alcohol as they may damage the surface of the unit.

Disposal of your old appliance

1. When this crossed-out wheeled bin symbol is attached to a product it means the product is covered by the European Directive 2002/96/EC.
2. All electrical and electronic products should be disposed of separately from the municipal waste stream via designated collection facilities appointed by the government or the local authorities.
3. The correct disposal of your old appliance will help prevent potential negative consequences for the environment and human health.
4. For more detailed information about disposal of your old appliance, please contact your city office, waste disposal service or the shop where you purchased the product.



About DAB

With this unit you can receive and listen to Digital Audio Broadcast (DAB) programmes. DAB uses digital, not analogue signals, resulting in near CD-quality audio with virtually interference-free reception. Along with superior quality audio, DAB can also deliver additional audio channels and text. In the future, computer data and images are also possible.

Digital radio is broadcast as groups of data called ensembles or multiplexes. Each multiplex can contain a number of stations (services) and each station contains a primary service and can contain secondary services as illustrated in the following diagram.

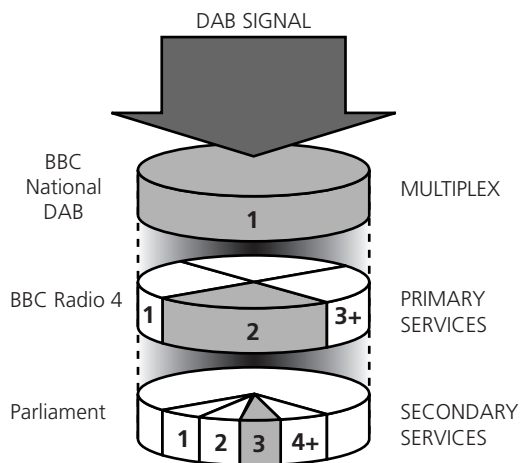

Each multiplex is transmitted in a set frequency range and received by this unit for decoding. You can receive multiplexes broadcast in the 174-240 MHz frequency band and store the services in each multiplex for you to access. The number of multiplexes you receive depend on your location. Channels used in the UK are in the range 10A to 12D.

Multiplexes and stations have labels (names) that are used to identify them. Instead of needing to know the particular frequency of your favourite broadcast, you can simply select the station name. Secondary services and additional data such as text or multiplex info are also available.

Specifications

FM Tuner

Tuning range 87.50 - 108.00 MHz (50 kHz steps)
Signal-to-Noise ratio 65 dB (Mono)
60 dB (Stereo)

AM Tuner

Tuning range 522 - 1620 kHz (9 kHz steps)
Signal-to-Noise ratio 35 dB

DAB Tuner

Tuning range Band 3, 174 MHz - 240 MHz
Input 50 ohms, nominal
Max signal -3 dBm typ
Sensitivity -96 dBm typ
Adjacent Channel Rejection 35 dB typ
Digital output 24 bit/48 kHz resolution

Audio output Stereo, 2.5 Vp-p

General

Power requirements AC 230 V, 50 Hz
Power consumption 9 W (Standby: 3 W)
Dimensions (W x H x D) 215 x 93 x 305 mm
Weight 2.5 kg

Operating temperature +5°C - +35°C
Operating humidity 5% to 85% (no condensation)
Storage temperature -20°C - +55°C

Accessories

AM loop antenna x 1
FM Lead-type antenna x 1
DAB antenna x 1
RCA pin cable x 1
Remote control connection cord x 1

- Design and specifications are subject to change without notice.
- Weight and dimensions are approximate.
- Illustrations may differ slightly from production models.

TEAC

TEAC CORPORATION	3-7-3, Nakacho, Musashino-shi, Tokyo 180-8550, Japan Phone: (0422) 52-5081
TEAC AMERICA, INC.	7733 Telegraph Road, Montebello, California 90640 Phone: (323) 726-0303
TEAC CANADA LTD.	5939 Wallace Street, Mississauga, Ontario L4Z 1Z8, Canada Phone: (905) 890-8008
TEAC MEXICO, S.A. De C.V	Campesinos N°184, Colonia Granjas Esmeralda, Delegacion Iztapalapa, CP 09810, México DF Phone: (525) 581-5500
TEAC UK LIMITED	Unit 19 & 20, The Courtyards, Hatters Lane, Watford, Hertfordshire, WD18 8TE, U.K. Phone: (0845) 130-2511
TEAC EUROPE GmbH	Bahnstrasse 12, 65205 Wiesbaden-Erbenheim, Germany Phone: 0611-71580
TEAC AUSTRALIA PTY., LTD. A.B.N. 11 113 998 048	30 Tullamarine Park Road, Tullamarine, VIC 3043, Australia Phone: (03) 8336-6500

This appliance has a serial number located on the rear panel. Please record the model number and serial number and retain them for your records.

Model number _____ Serial number _____